

The Grundfos ALPHA2 L domestic circulator is one of the most advanced energy efficient domestic circulators of its kind on the market today. It is the ideal choice for a variety of domestic circulation heating systems, having both variable speed pressure controlled operation, and standard selectable three speed operation.

The ALPHA2 L is an 'A' Rated Energy labelled product, achieving the highest possible energy savings under the current energy labelling scheme. The reduction in power consumption has been achieved by using the latest permanent magnet motor technology. Using pressure controlled operation power consumption can be reduced to as low as 5 watts.

The variable speed modulating modes allow the pump to match its performance to the system requirements, helping to reduce noise when thermostatic valves are closing down.

The ALPHA2 L models are simple to install as new or replacement pumps, and are 130mm between ports.

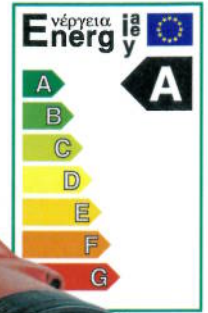

FEATURES AND BENEFITS

- 'A' Rated energy label – lowest power consumption
- Energy efficient pump - significant energy savings
- Variable and fixed speed operation – one pump for all jobs
- Plug and Pump – no need to open terminal box

TECHNICAL DATA

- Liquid Temperature:** +2°C @ 110°C
- Maximum Ambient:** 37°C @ 82°C Flow
- Min Inlet Pressure:** 1.3m @ 82°C Flow
- Maximum System Pressure:** 10 Bar
- Mean Sound Pressure Level:** <43 dB(A)

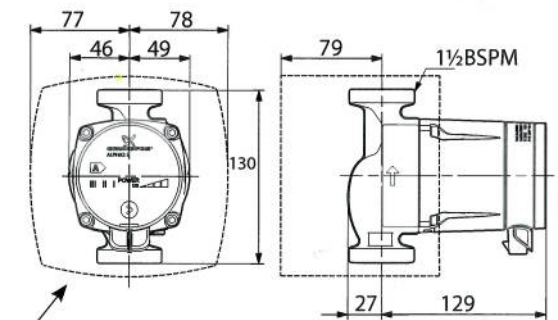
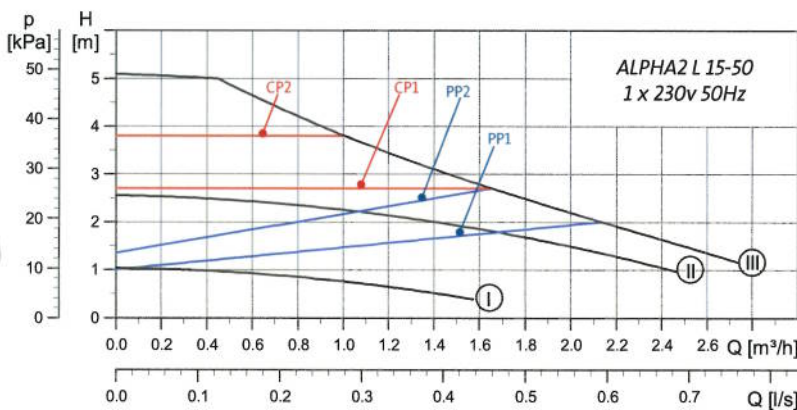

OPTIONAL INSULATION SHELL
Part No:505821

Weight kg: Net 1.9, Gross 2.1

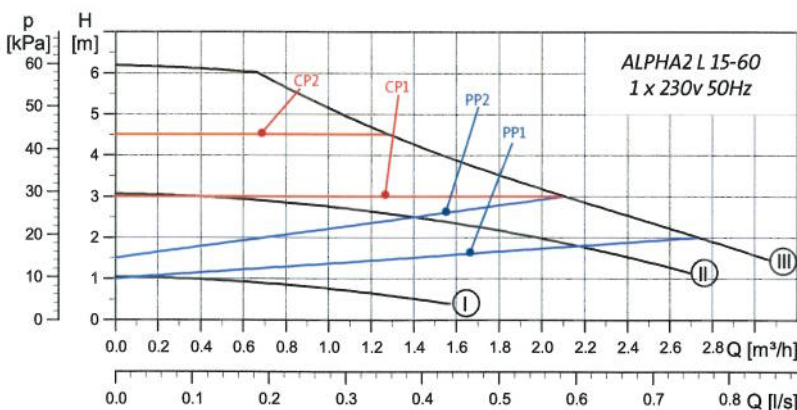

— CP=Constant Pressure — PP=Proportional Pressure

PUMP	SPEED SETTING	MODE	INPUT PI (W)	FLC (A)
ALPHA2 L 15-50	I	FIXED	8	0.07
	II		24	0.21
	III		32	0.27
	MIN	MOD	5	0.05
	MAX	MOD	32	0.27
ALPHA2 L 15-60	I	FIXED	8	0.07
	II		31	0.27
	III		45	0.38
	MIN	MOD	5	0.05
	MAX	MOD	45	0.38

CONTROL OF HEATING SYSTEMS

The heat requirements of a building vary greatly and today thermostatic radiator valves efficiently control the system output. This can lead to excessive pump pressure and valve noise. ALPHA2 L can not only adapt to these variable conditions but reduce electrical energy consumption.

FIXED SPEED PUMP MODE

With a fixed speed pump, as the radiator TRV's close, the system resistance increases (A1 to A2) causing an increase in pump pressure (ΔH_1) which can lead to TRV valve noise.

PRESSURE CONTROLLED MODE

As the radiator TRV's close (A1 to A2) the pump pressure is controlled according to the selected mode (A1 to A3). At the reduced pressure the TRV's then re-adjust to maintain the required radiator output. The pump pressure reduces radiator valve noise and power consumption.

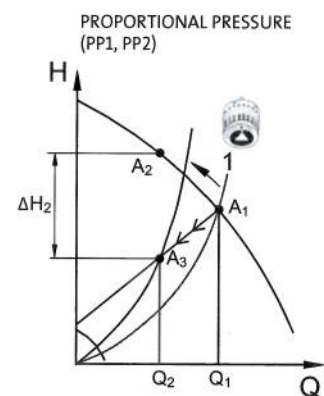
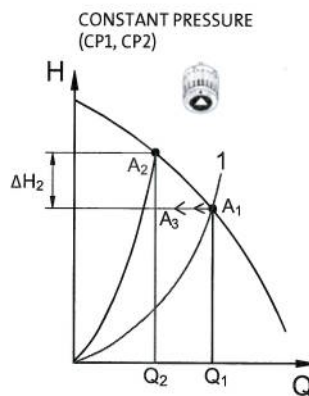
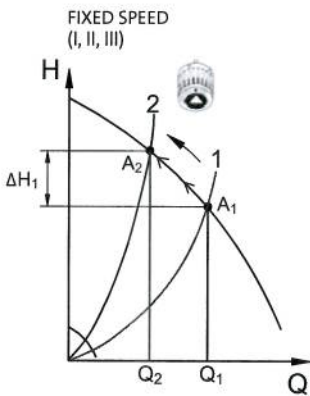

ALPHA2 L FUNCTIONALITY AND SETTINGS

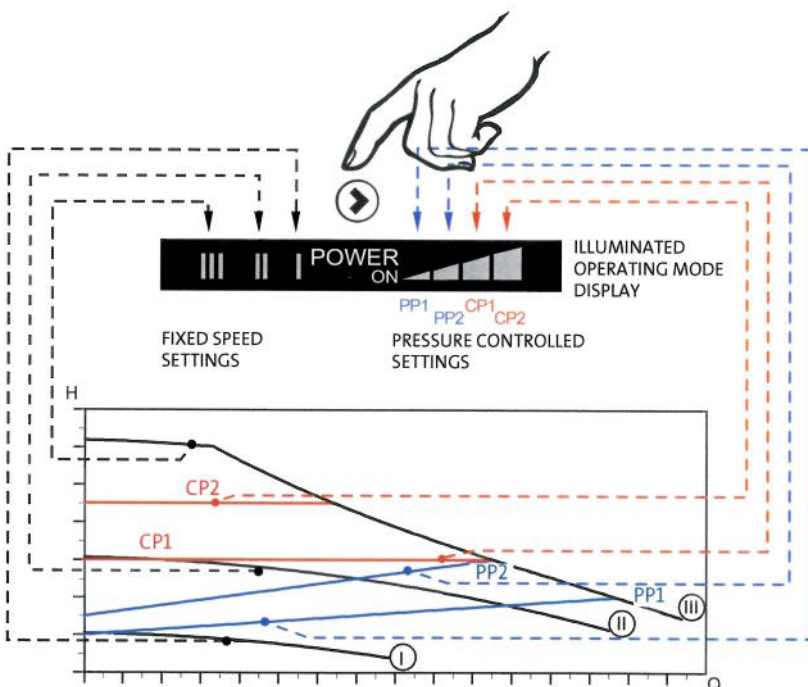

SETTING	PUMP CURVE	TYPICAL APPLICATION
I, II, III	Fixed Speed operation	System without TRVs
CP1 CP2	Lower (CP1) & higher (CP2) constant pressure	Underfloor systems. TRV systems with ABV installed
PP1 PP2	Lower (PP1) & higher (PP2) proportional pressure	TRV systems with no minimum flow requirement*

ABV = Automatic Bypass Valve TRV = Thermostatic Radiator Valve

INSTALLATION AND OPERATING GUIDANCE

When installing the ALPHA2 L, please refer to the Installation and Operating Instructions, if using pump in either constant pressure or proportional pressure mode.

*Please refer to the boiler manufacturers minimum flow rate requirements when setting bypass valves.